

Optional equipment: Reclinable trellis jib 6.2 / 12 m

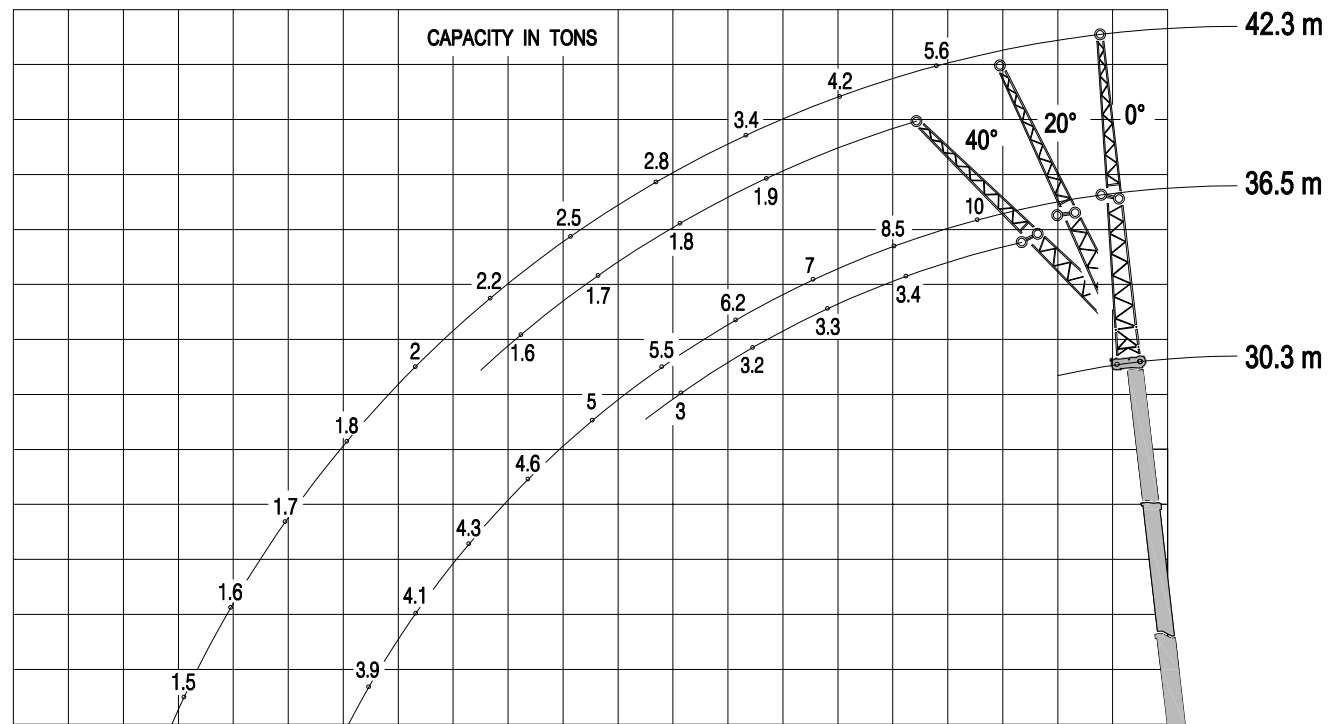

**IDROGRU**  
CRANE

**KT 200.33**

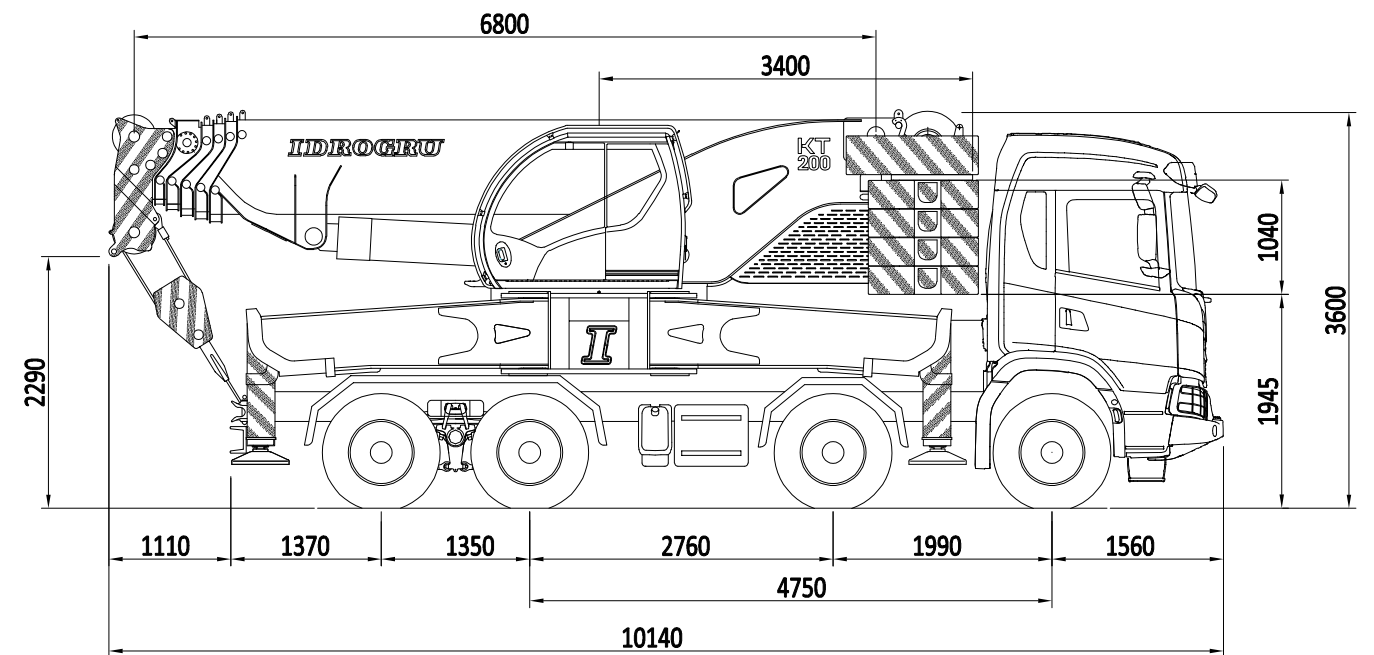

Divisible counterweight with automatic unloading

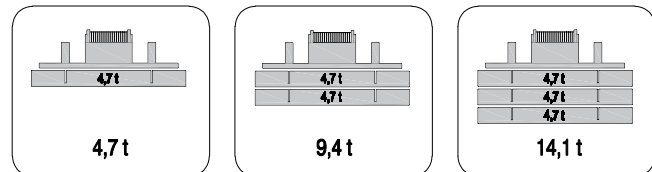

1,5 meters mechanic jib (for hook or pulley) with an extension of 1,5 meters.

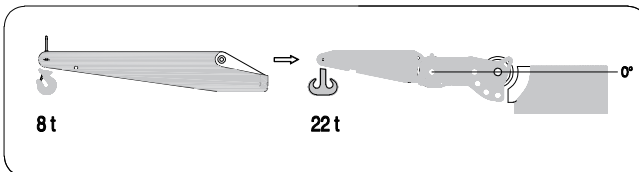

0,5 meters hook for reclinable boom head at -60° -30° 0°

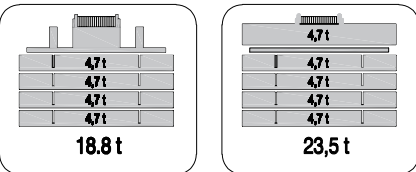
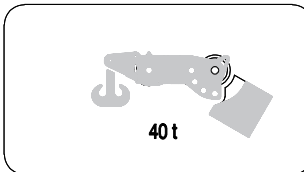

Hook blocks of various capacities

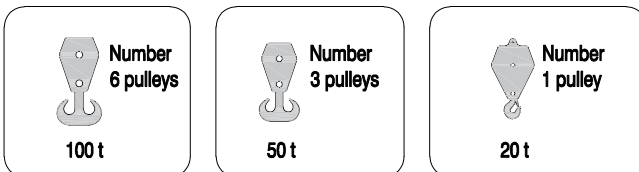

Three position reclinable boom head

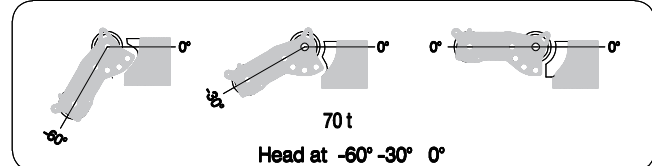

3 meters trellis jib

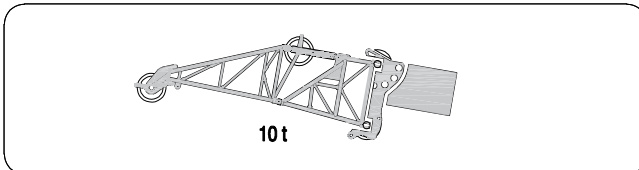

Primary winch

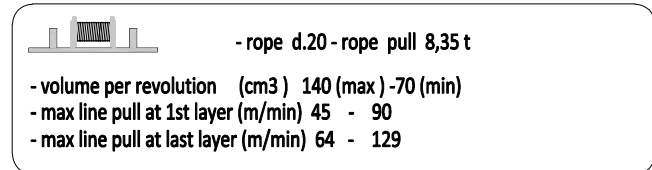

3,7 meters lift spreader beams

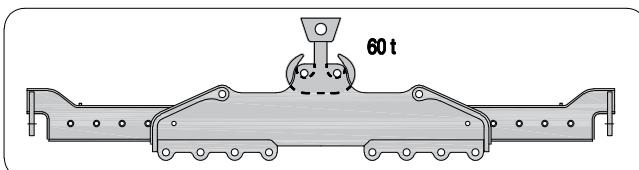

Double winch

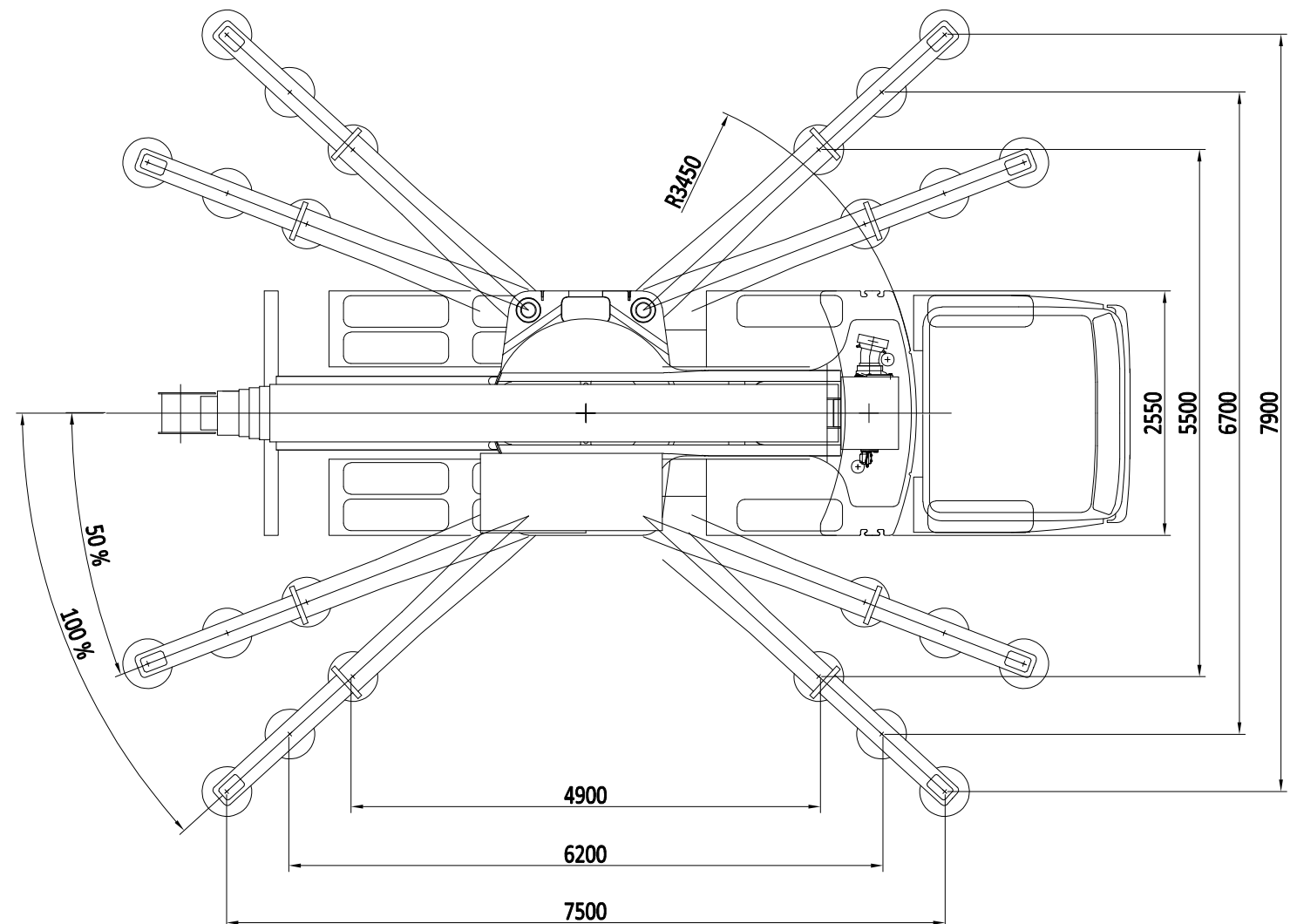
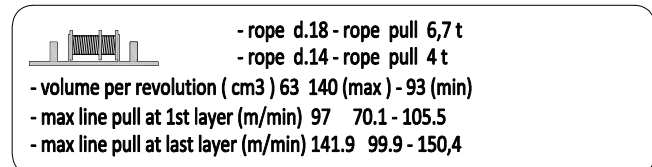

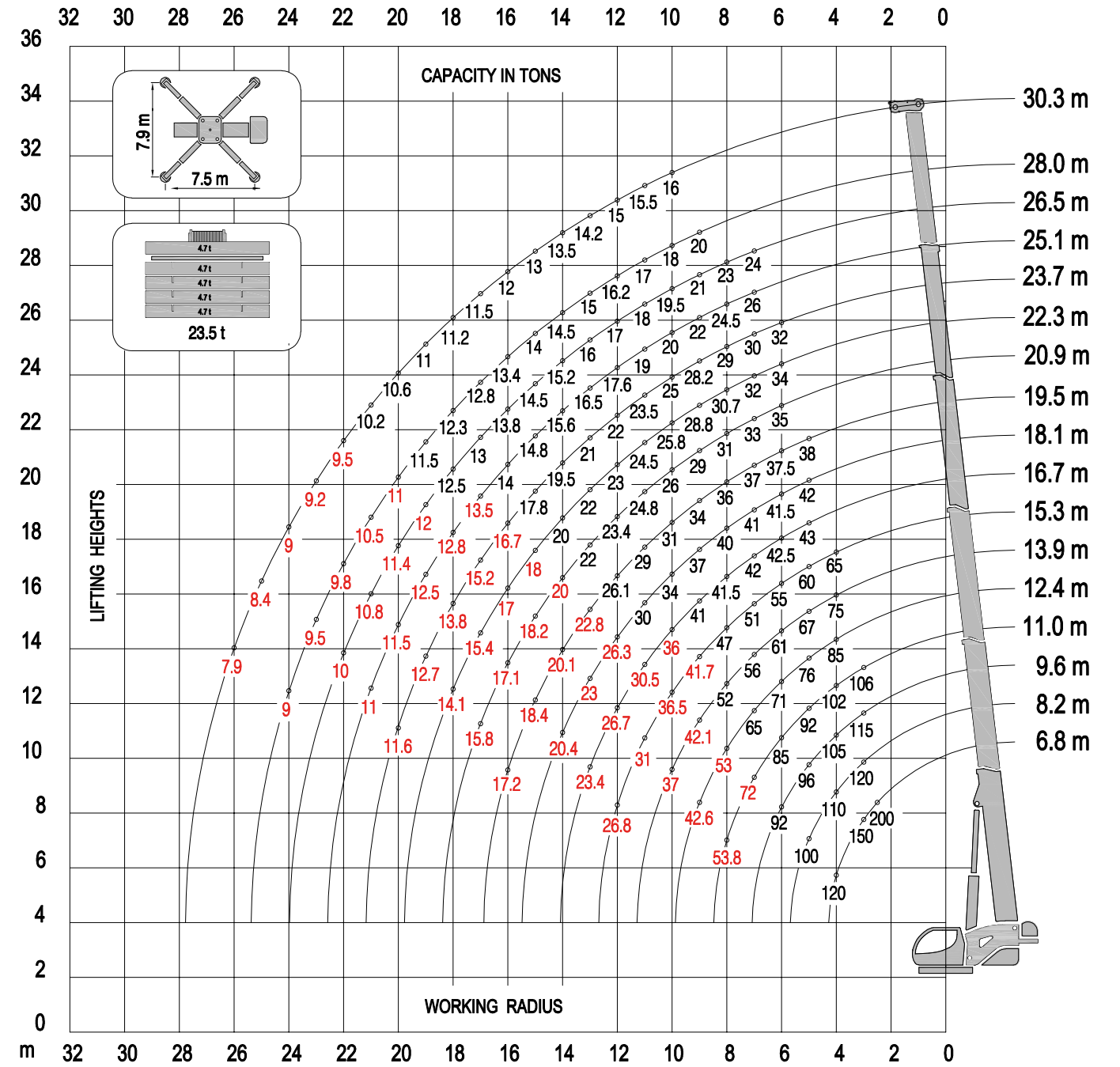
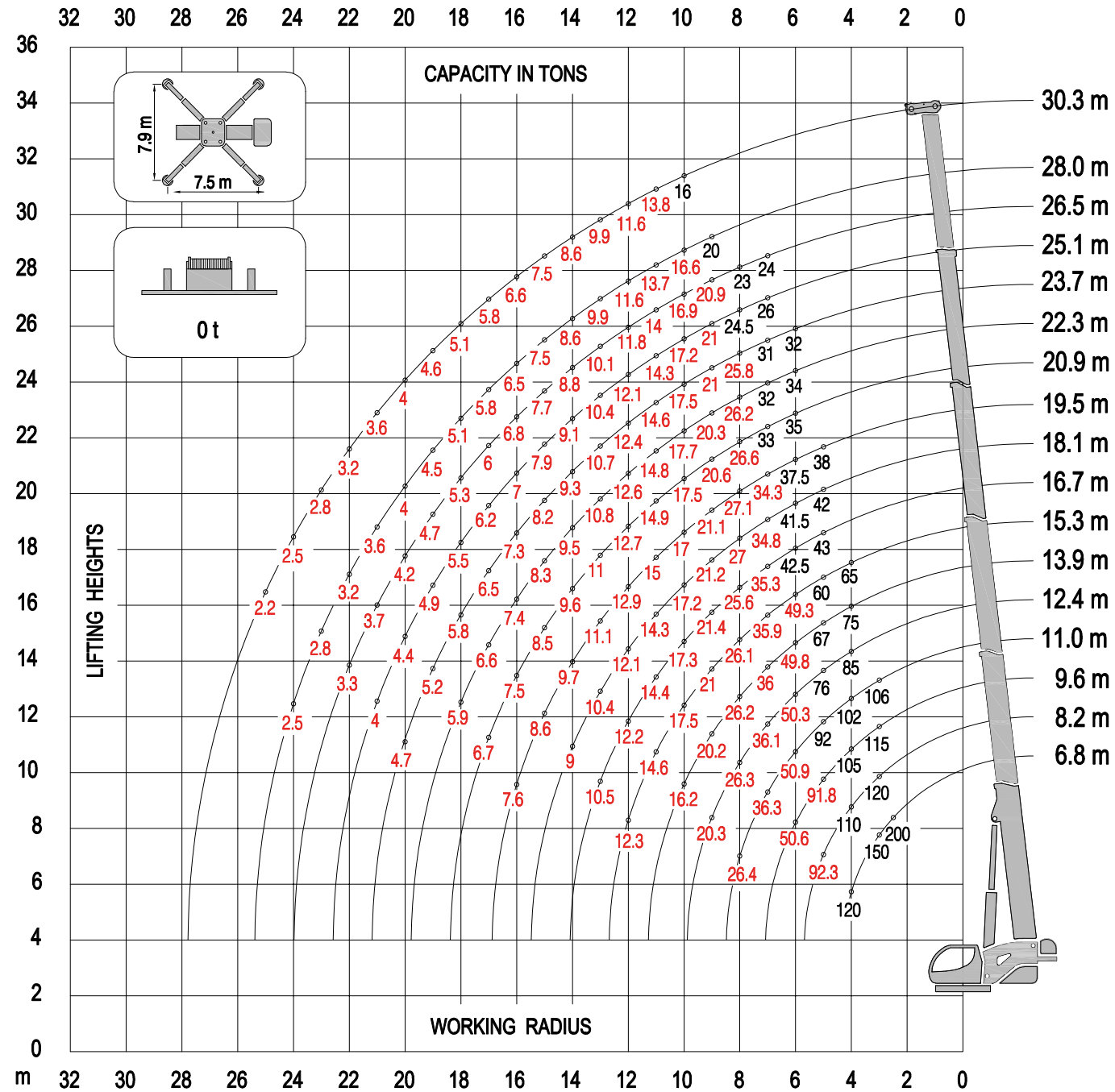

**Max Payload:** 100 t

The lifting capacities in the structural area are based on DIN 15018 part 3 / FEM 5.004 / EN 13000.  
The lifting capacities in the stability area are based on DIN 15019 part 2 / ISO 4305 / EN 13000.